

# SUNRISE OUTDOOR LTD 2022

SUNRISE  
UMBRELL

 sunbrella® Fabric



## SUNRISE OUTDOOR LTD

Rm 427, Tianyihaojing Block A, No.19 Hualou Lane, Ningbo, 315010, China  
Tel : +86 (574) 8768 0079

support@ningbo-sunrise.com  
patioumbrella007@gmail.com  
<http://sunrise-outdoor.com>

# About Us

In the year 1993, our team started to design and develop garden umbrellas and gazebos for European market.

In the year 1998, we found our own factory SUNRISE OUTDOOR LTD. Ningbo, China, which produce sunshade products such as garden umbrellas, gazebos, and protective covers for outdoor furniture. Our factory has 30,000m<sup>2</sup> workshop and 5,000m<sup>2</sup> showroom.

In the year 2012, we established our sunshades design center in Los Angeles, USA, has office and warehouse 20000 CFT. And we became a member of the ICFA (International Casual Furnishings Association) in Chicago, USA. Also, we've attended the ICFA Market in Chicago, National Hardware Show, Lawn & Garden World and Housewares Show, and Spoga Fair in Germany.



We supply our products to North America, Europe, Australia, the Middle East and South America, Africa and Asia over 30 countries. They are very satisfied with our quality and after sales service.

Our company has been an active participant of the Business Social Compliance Initiative (BSCI), which supports companies to drive social compliance and improvements within the factories in their global supply chains.

We have full confidence to work with customers closely to provide the customised services of designing, manufacturing to meet our clients' individual needs and expectations, while delivering value for money.

Be partner, grow together!

## NINGBO SUNRISE OUTDOOR PRODUCTS LTD

Rm 427, Tianyihaojing Block A, No.19 Hualou Lane, Ningbo, 315010, China

<http://sunrise-outdoor.com>

Fax : +86 (574) 8732 7989 Tel : +86 (574) 8768 0079

E-mail : [support@ningbo-sunrise.com](mailto:support@ningbo-sunrise.com)  
[patioumbrella007@gmail.com](mailto:patioumbrella007@gmail.com)

# Company Profile

## Business Type

- Manufacturer, exporter
- Export Percentage**
- 100 percent

## Primary Competitive Advantages

- Experienced R&D Department and workers
- OEM Capability
- Production Capacity
- Reliability
- Reputation
- Buyer's Specifications Accepted

## QC Responsibility

- YES

## Year Established

- 1998

## Types of Plant & Machinery in Factory

- Cutting and stripping machines
- Forging and press equipment
- Lifting and drawing equipment
- Electric and fuel power equipment
- Welding machines
- Instruments and meters
- Plastic process equipment
- Sewing equipment
- Environment safeguard equipment
- Powder coating and paint equipment
- Non-production accessorial equipment
- Lift forklift

## Current Export Markets

- Western Europe
- North America
- Australia

## Production Type

- Wholly owned

## No. of R&D Staff

- 20

## No. of Engineers

- 20

## Monthly Capacity

- 20,000sets to 30,000 sets

## Product Range

- Garden umbrellas
- Gazebos
- Balcony awnings
- Canopies and protective covers for outdoor furnitures

## Factory Size In Square Meters

- 30,000m<sup>2</sup> (300,000 square feet)

## Size of showroom

- 5,000m<sup>2</sup> (50,000 square feet)



**SUNNY OUTDOOR INC.**

**SUNRISE UMBRELLA INC.**

4751 Littlejohn St, # A, Baldwin Park, CA 91706, USA

Tel : +1(626) 338-1217 / +1(626) 337-1717

E-mail : [patioumbrella007@gmail.com](mailto:patioumbrella007@gmail.com)

# Fabrics

## 1. Sunbrella

- American Brand
- 5 years warranty



## 2. Strongcamel

- Ningbo Sunrise Brand, China
- 2 years warranty



**Color Fastness to Light** (ISO 105 B02:1994/Amd 1:1998 + Amd 2:2000; use Xenon arc lamp)  
**Grade (Blue Wool Standard):**  Grade 5,  Grade 6

## 3. Economic

- China Brand
- 1 year warranty

- 100% Polyester
- T/C Fabric (65% polyester, 35% cotton)
- 100% cotton
- 100% acrylic
- PE mesh



**Color Fastness to Light** (ISO 105 B02:1994/Amd 1:1998 + Amd 2:2000; use Xenon arc lamp)  
**Grade (Blue Wool Standard):**  Grade 3,  Grade 4

## 4. Treatment

- Water repellent
- Water resistant
- UV treated
- PVC coating
- PA coating
- PU coating

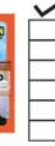

## 5. Care, cleaning & maintenance

Fabric should be cared & cleaned regularly before substances such as dirt, roof particles, etc., accumulated on and become embedded in the fabric. The fabric can be cleaned without being removed from the installation. Simply brush off any loose dirt, roof particles, etc.; hose down and clean with a mild solution of natural soap in lukewarm water (no more than 100 degree F.). Rinse thoroughly to remove soap. DO NOT USE DETERGENTS. Air dry is fine.

Please care & clean the fabrics regularly before storing, and covering with a protective umbrella cover is a wise way for longer life of your canopy.  
Please close your garden umbrellas or gazebos in strong windy or stormy conditions.

# Enjoy The Sun Safely - Textile UV Protection

## Ultraviolet Protection Factor (UPF)

The UV protection factor states how long someone wearing UV protective clothing can stay out in the sun without suffering skin damage. The Ultraviolet Protection Factor (UPF) is comparable to the sun protection factor of sunscreen (SPF). In both cases, the basis for calculations is what is known as the intrinsic protection time of the skin, which can vary considerably depending on the individual skin type.

The skin of someone of skin type I with red or blond hair, blue eyes and a very fair complexion has an intrinsic protection time of approximately five to ten minutes. If they are exposed to the burning sun for longer than this without protection, they risk harmful sunburn.

When protected by a textile material with a UPF of 20, for example, this individual can extend how long they are able to stay in the sun by a factor of 20, in other words, up to a maximum of 1.5 to 3 hours (20 x 5 min = 100 min to 20 x 10 min = 200 min), without risking damage to their skin.

## TEXTILE UV PROTECTION

Textiles are intrinsically suited for use as UV protection, as they are able to offer particularly good protection against intense radiation from the sun if suitable materials and constructions are used. UV protection factors (UPF) far above those of the strongest sunscreens (sunblocks) can be achieved.

It is not possible to determine how much UV radiation a textile allows to penetrate the skin simply from looking at and feeling the textile and thereby give a UV protection factor comparable to those used for cosmetic sun screens.

UV index	Children's skin	Skin type I	Skin type II	Skin type III	Skin type III
3-4	UPF20	UPF20	UPF15	UPF10	UPF5-10
5-6	UPF20-40	UPF20-40	UPF20-40	UPF20	UPF10
7-8	UPF60-80	UPF60-80	UPF40-60	UPF40	UPF20
9 and above	UPF80	UPF80	UPF60-80	UPF60	UPF40

-Australian-New Zealand standard: (AS/NZS 4399:1996),

-American standard: AATCC 183.

-European standard: UV Standard 801



## Manufacturing Center Ningbo China





**SUNRISE OUTDOOR LTD**

Rm 427, Tianyihaojing Block A, No.19 Hualou Lane, Ningbo, 315010, China

Tel : +86 (574) 8768 0079

support@ningbo-sunrise.com

patioumbrella007@gmail.com

http://sunrise-outdoor.com

**SELF OPEN**  
HEAVYDUTY Umbrella

**U10-500** ☉ Octagonal 16.4' (5m)  
**U10-600** ☉ Octagonal 20' (6m)  
**U10-700** ☉ Octagonal 23' (7m)

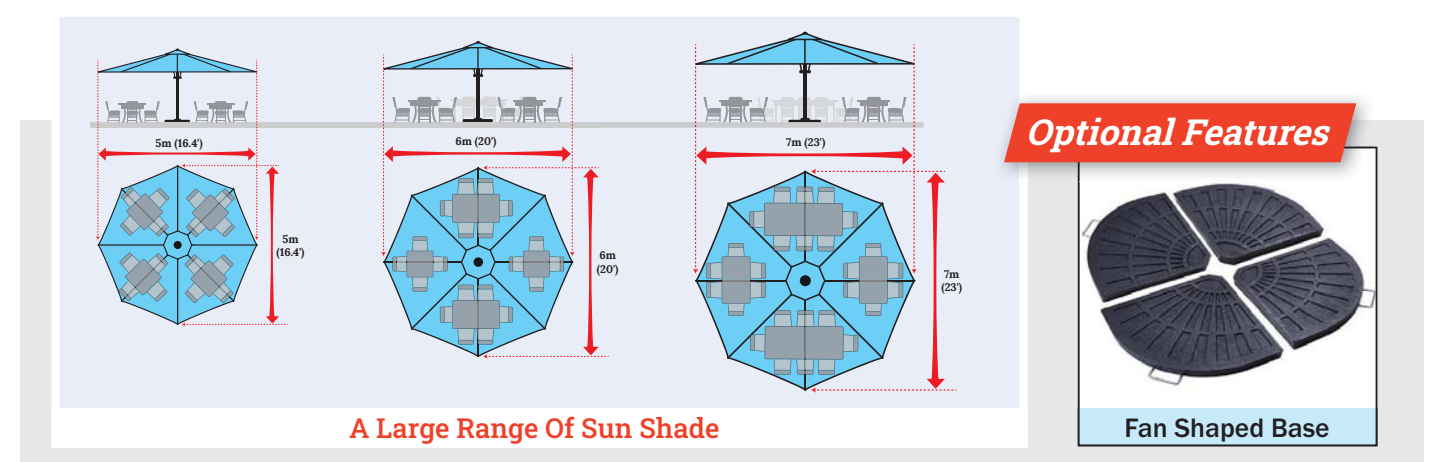

# SELF OPEN

HEAVYDUTY Umbrella

**U10-500** ☒ Octagonal 16.4' (5m)

**U10-600** ☒ Octagonal 20' (6m)

**U10-700** ☒ Octagonal 23' (7m)



**U10-600**

# SELF OPEN

HEAVYDUTY Umbrella

**U10-404** ☒ Square 13' X 13' (4 x 4m)

**U10-505** ☒ Square 16.4' X 16.4' (5 x 5m)



**U10-505**

**U10**  
GENERATION-X



## Self Opening System



**U10**  
GENERATION-X



## Self Opening System



**U10-404**

## Special Features

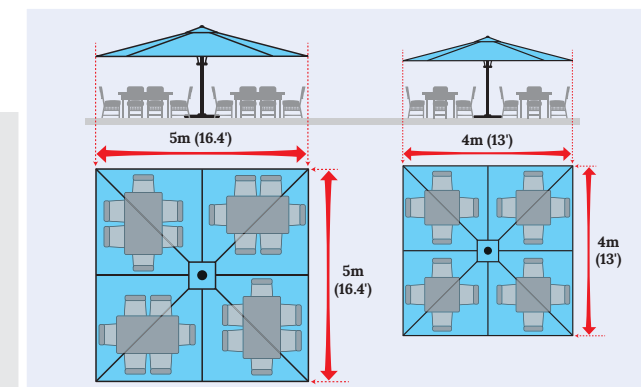
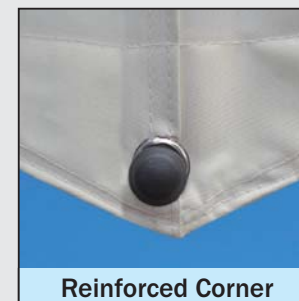
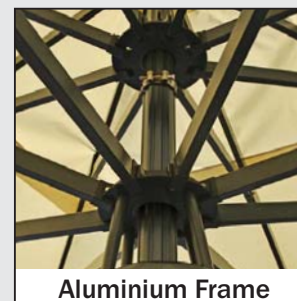
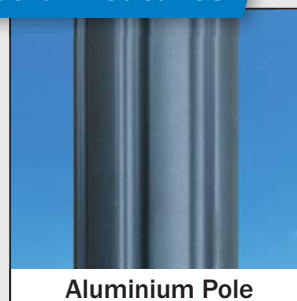

A Large Range Of Sun Shade



PC-05 for U10-505, U10-600, U10-700

**SELF OPEN**  
Rechargeable Battery Lighting

- U10-404L** ☒ Square 13' X 13' (4 x 4m)
- U10-505L** ☒ Square 16.4' X 16.4' (5 x 5m)



**GAZEBRELLA**  
HEAVYDUTY GAZEBO

- GU10-500** ☒ Octagonal 16.4' (5m)
- GU10-600** ☒ Octagonal 20' (6m)
- GU10-700** ☒ Octagonal 23' (7m)
- GU10-404** ☒ Square 13' X 13' (4 x 4m)
- GU10-505** ☒ Square 16.4' X 16.4' (5 x 5m)



**Protective Cover**



**PC-04** for U10-404, U10-500



**SELF OPEN GAZEBRELLA**



Large Enough Space To Fit Into Multiple Tables

**Special Features**

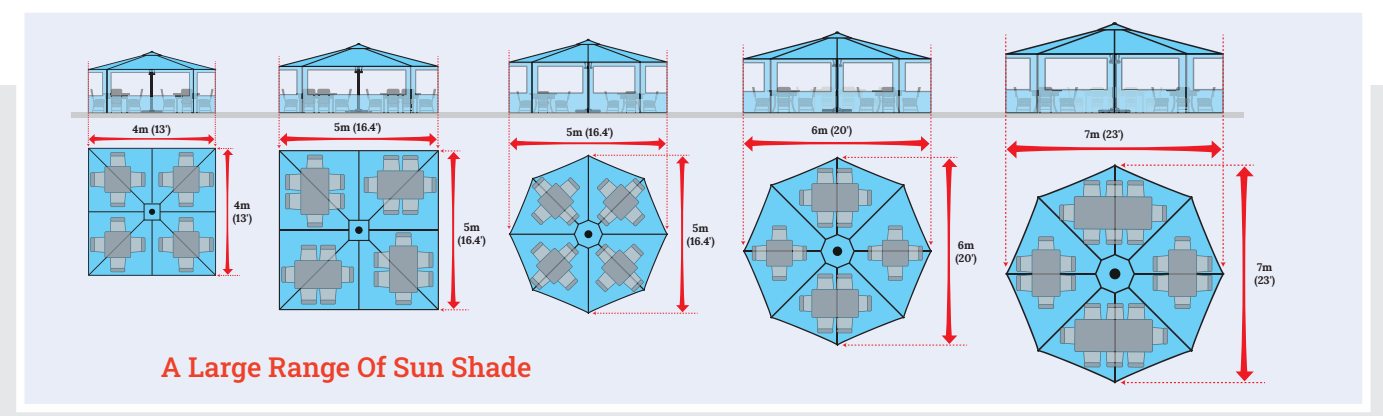

# EASY ROMA

One Step Cantilever Umbrella

- U9-250X** ☒ Square 8' x 8' (2.5 x 2.5m)
- U9-303** ☒ Square 10' x 10' (3 x 3m)

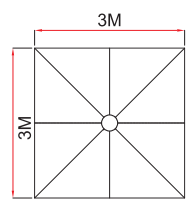

**Self Open & Easy to Close**

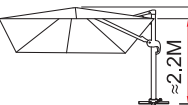

**U9-303**  
 □ 3 x 3 M  
 = 9.0 M<sup>2</sup>  
 ≈ 24.5 KG  
 ≈ 27.5 KG  
 60 KM/H

### Special Features



Aluminium Pole

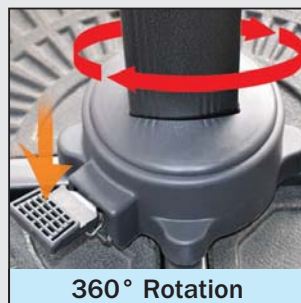

360° Rotation



Hydraulic Gas Spring

# EASY ROMA

One Step Cantilever Umbrella

- U9-250XL** ☒ Square 8' x 8' (2.5 x 2.5m)
- U9-303L** ☒ Square 10' x 10' (3 x 3m)

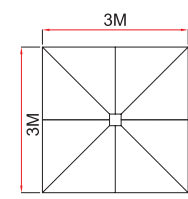

**Self Open & Easy to Close**

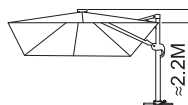

**U9-303LA**  
 □ 3 x 3 M  
 = 9.0 M<sup>2</sup>  
 ≈ 24.5 KG  
 ≈ 27.5 KG  
 60 KM/H

### Optional Features



Granite Weight



Rolling Base



Fan Shaped Base

### Special Features



Power Switch



Center Lights



LED Lights

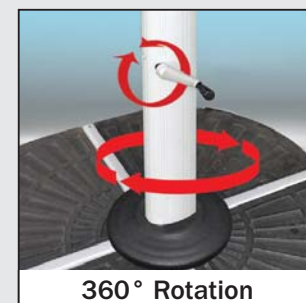

360° Rotation

# EASY ROMA

One Step Cantilever Umbrella

- U9-300** ☒ Round 10' (3m)
- U9-350** ☒ Round 11.5' (3.5m)



**U9-300**  
 ∅ 3 M  
 ≈ 7.06 M<sup>2</sup>  
 ≈ 22.8 KG  
 ≈ 25.8 KG  
 60 KM/H

**Self Open & Easy to Close**

**EASY PUSH UP One Step**

### Special Features

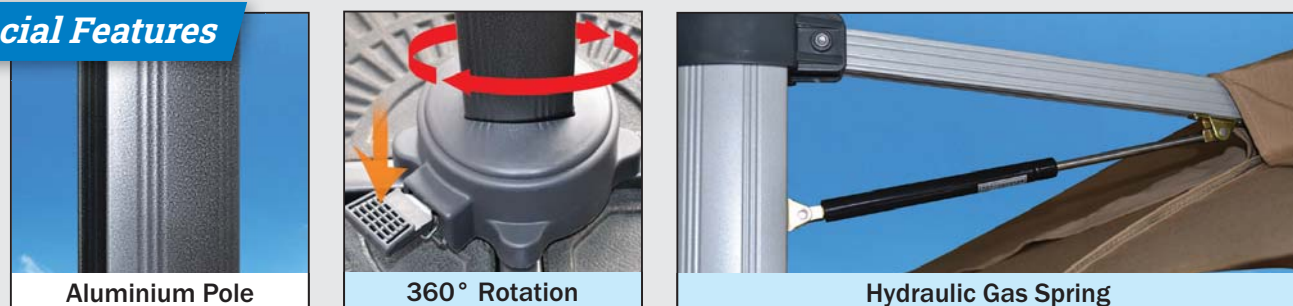

# EASY ROMA

One Step Cantilever Umbrella

- U9-300L** ☒ Round 10' (3m)
- U9-350L** ☒ Round 11.5' (3.5m)



**U9-300L**  
 ∅ 3 M  
 ≈ 7.06 M<sup>2</sup>  
 ≈ 22.8 KG  
 ≈ 25.8 KG  
 60 KM/H

**Self Open & Easy to Close**

**EASY PUSH UP One Step**

**Optional Features**

**55LBS UB073**

Granite Weight

**UB087**

Rolling Base

**UB017**

Fan Shaped Base

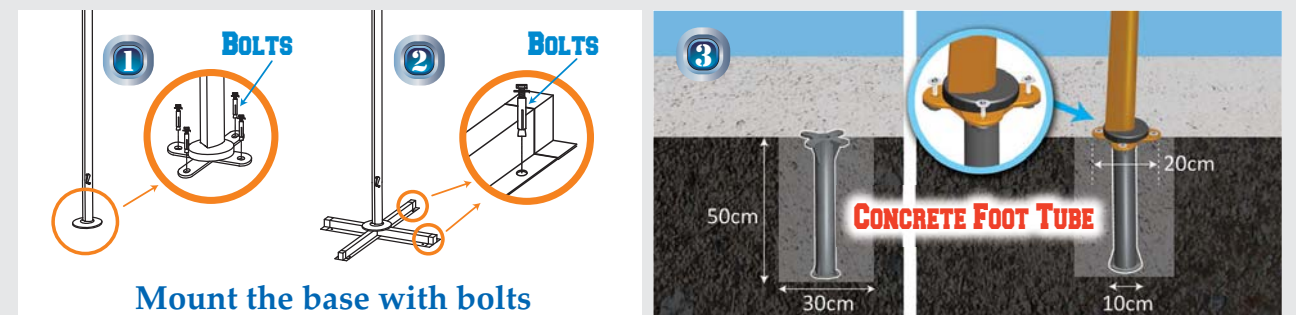

# HEAVYDUTY

Commercial umbrella

**U8-303F-2** ☒ Square 10' x 10' (3 x 3m)

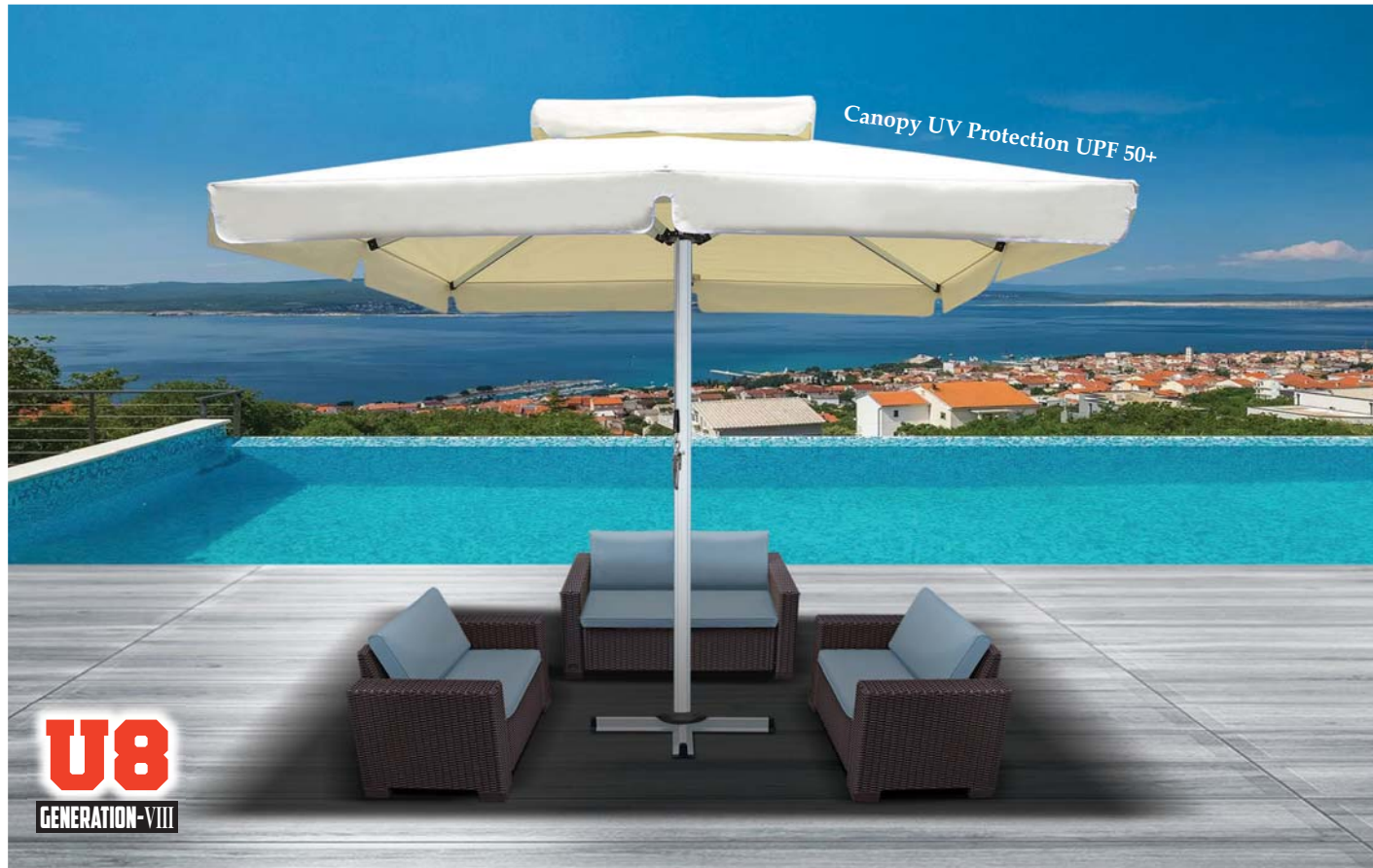

# HEAVYDUTY

Commercial umbrella

**U8-250X** ☒ Square 8' x 8' (2.5 x 2.5m)  
**U8-270X** ☒ Square 9' x 9' (2.7 x 2.7m)  
**U8-303** ☒ Square 10' x 10' (3 x 3m)

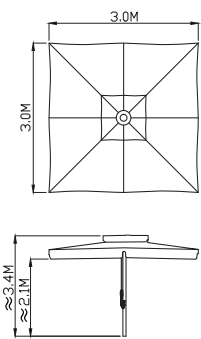

### Handle Mechanism



**U8-303F-2**  
 □ 3X3M  
 = 9.0M<sup>2</sup>  
 ≈ 23KG  
 ≈ 27KG  
 95KM/H

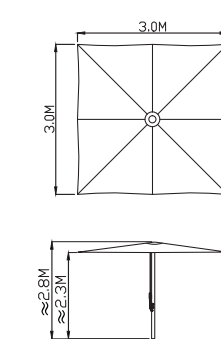

### Handle Mechanism

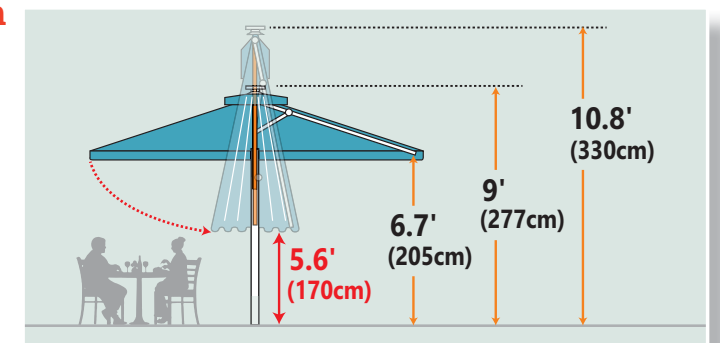

**Free Seating** No need to remove seating or tables beforehand

**U8-303**  
 □ 3X3M  
 = 9M<sup>2</sup>  
 ≈ 21KG  
 ≈ 24KG  
 90KM/H



**ALUMINIUM FRAME**  
 DURABLE & STRENGTH

### Special Features

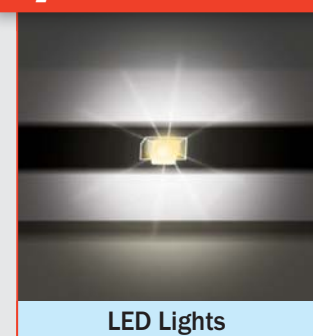

### Optional Features



**ALUMINIUM FRAME**  
 DURABLE & STRENGTH

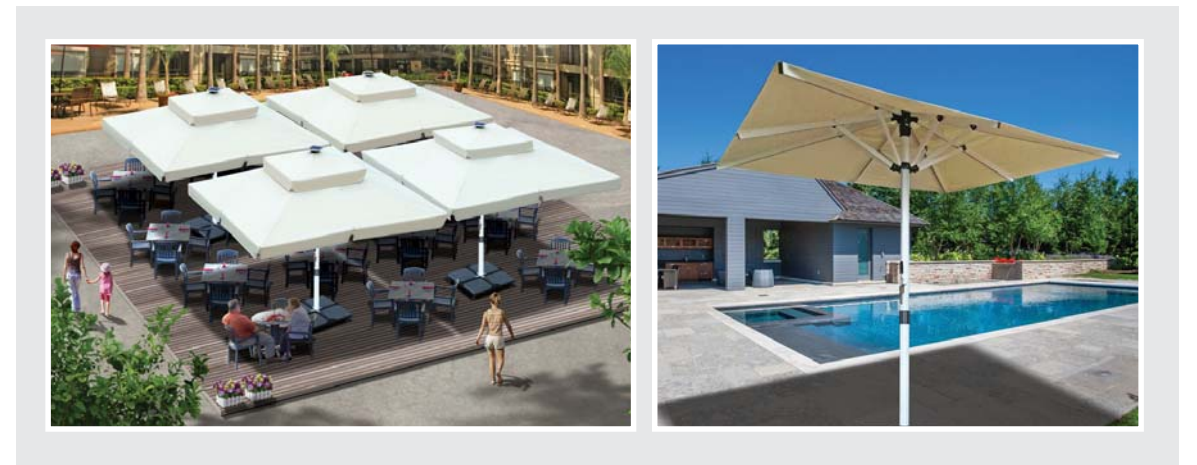





**U8**  
GENERATION-VIII

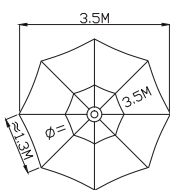

**Handle Mechanism**

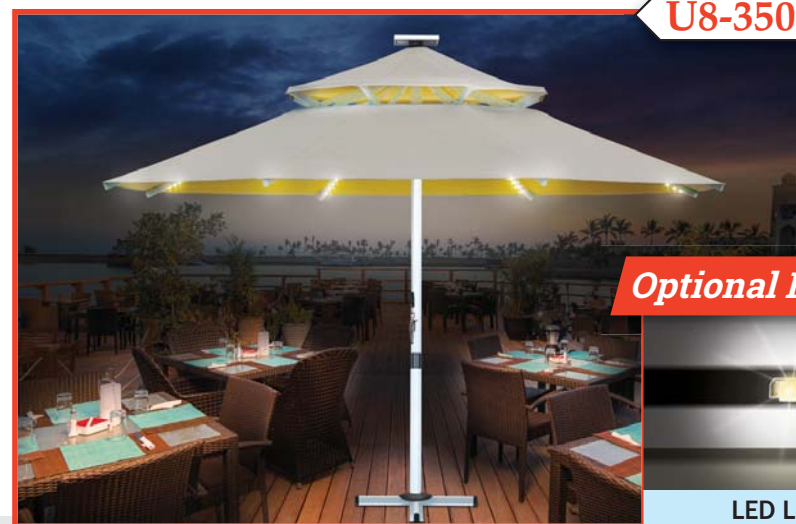

**U8-350-2L**

**Optional Features**

LED Lights

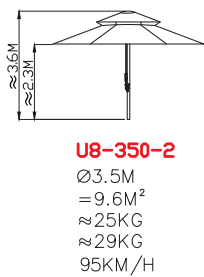

**U8-350-2**  
Ø3.5M  
= 9.6M<sup>2</sup>  
≈ 25KG  
≈ 29KG  
95KM/H



**ALUMINIUM FRAME**  
DURABLE & STRENGTH



**Hinge Base**



**U8**  
GENERATION-VIII

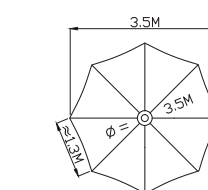

**Handle Mechanism**



**Wind Resistant**  
Up To 100 KPH!

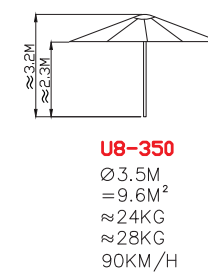

**U8-350**  
Ø3.5M  
= 9.6M<sup>2</sup>  
≈ 24KG  
≈ 28KG  
90KM/H



**ALUMINIUM FRAME**  
DURABLE & STRENGTH

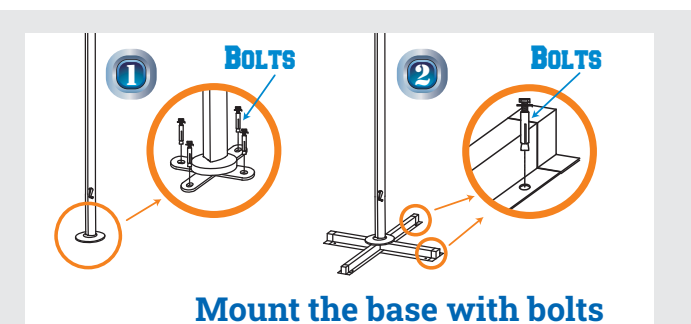

**Mount the base with bolts**

**Optional Features**



Granite Weight

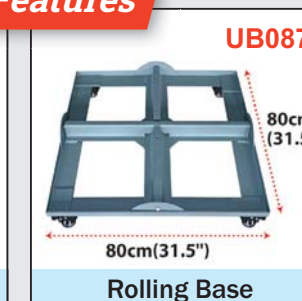

Rolling Base



Square Base

# SPRING ROMA

Cantilever Umbrella

- U7-250XL** ☒ Square 8' x 8' (2.5 x 2.5m)
- U7-270XL** ☒ Square 9' x 9' (2.7 x 2.7m)
- U7-303L** ☒ Square 10' x 10' (3 x 3m)
- U7-203L** ☒ Rectangular 10' x 6.5' (3 x 2m)
- U7-304L** ☒ Rectangular 13' x 10' (4 x 3m)

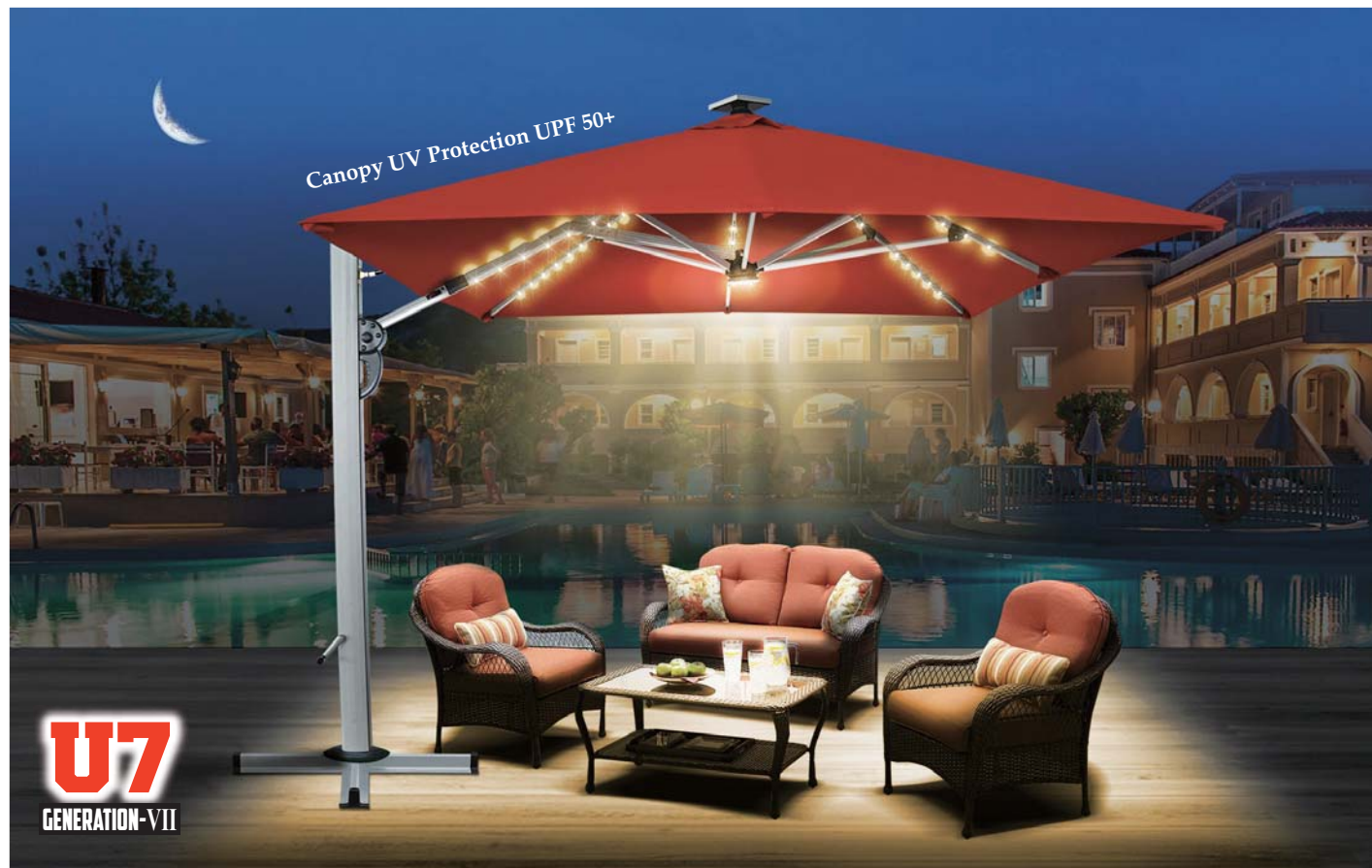

# SPRING ROMA

Cantilever Umbrella

- U7-250X** ☒ Square 8' x 8' (2.5 x 2.5m)
- U7-270X** ☒ Square 9' x 9' (2.7 x 2.7m)
- U7-303** ☒ Square 10' x 10' (3 x 3m)
- U7-203** ☒ Rectangular 10' x 6.5' (3 x 2m)
- U7-304** ☒ Rectangular 13' x 10' (4 x 3m)

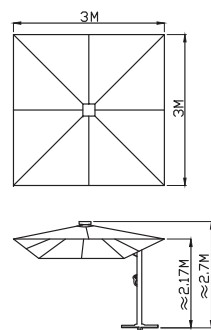

### Easy Open & Close



**U7-303L**  
 □ 3X3M  
 = 9M<sup>2</sup>  
 ≈ 24.5KG  
 ≈ 27KG  
 60KM/H

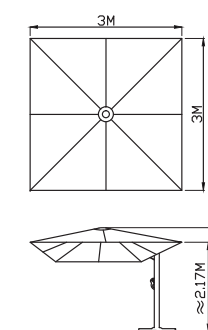

### Easy Open & Close

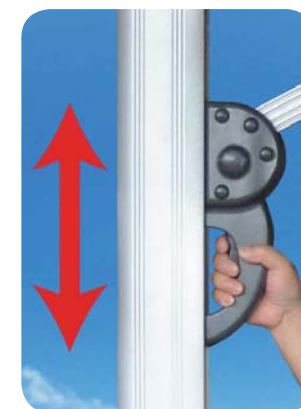

**U7-303**  
 □ 3X3M  
 = 9M<sup>2</sup>  
 ≈ 24.5KG  
 ≈ 27KG  
 60KM/H

### Special Features

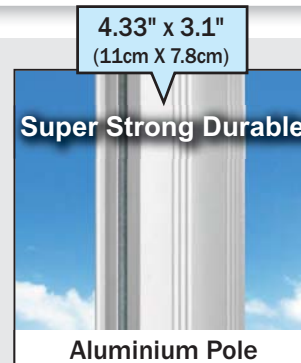
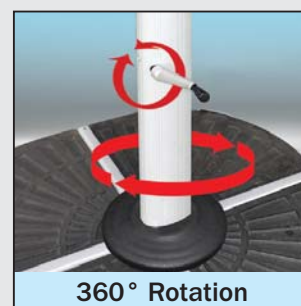

### Special Features



### Optional Features



# SPRING ROMA

Cantilever Umbrella

**U7-300L** ☒ Round 10' (3m)  
**U7-350L** ☒ Round 11.5' (3.5m)

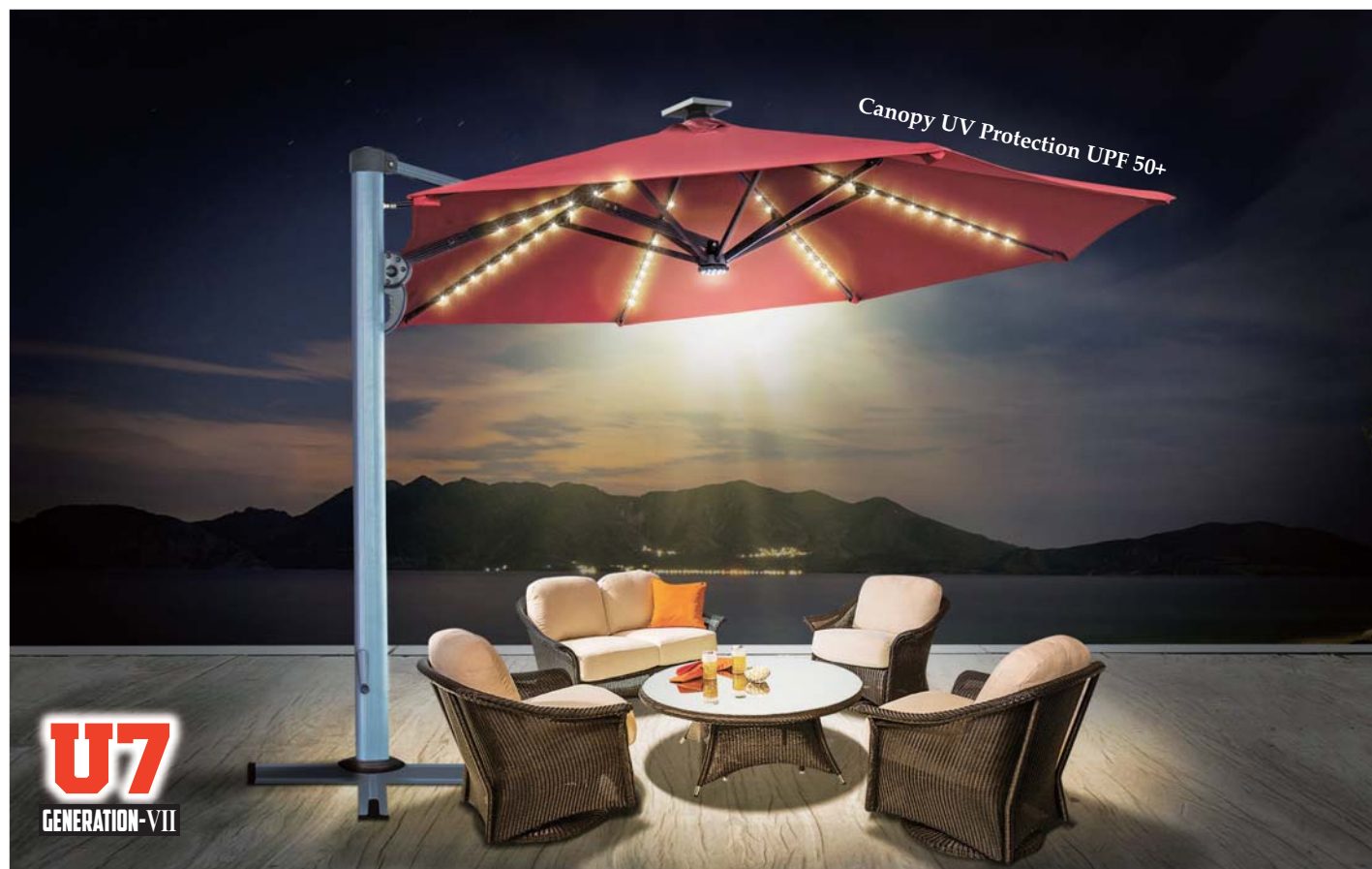

# SPRING ROMA

Cantilever Umbrella

**U7-300** ☒ Round 10' (3m)  
**U7-350** ☒ Round 11.5' (3.5m)

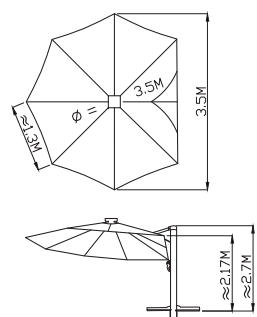

**Easy Open & Close**

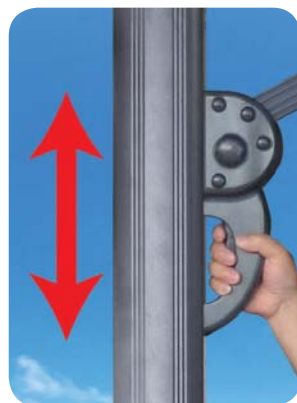

**U7-350L**  
 Ø3.5M  
 ≈9.6M<sup>2</sup>  
 ≈34KG  
 ≈37KG  
 55KM/H

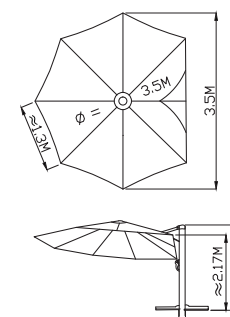

**Easy Open & Close**

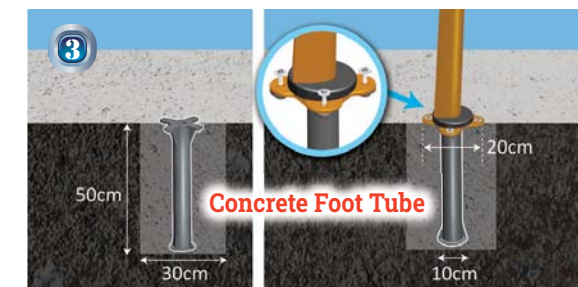
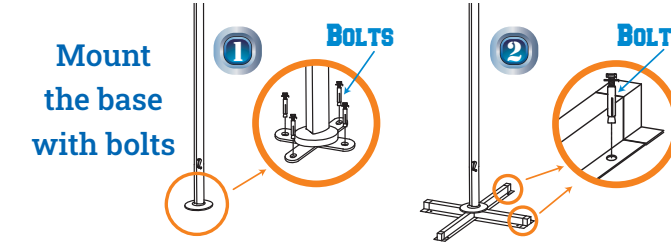

**U7-350**  
 Ø3.5M  
 ≈9.6M<sup>2</sup>  
 ≈34KG  
 ≈37KG  
 55KM/H

## Special Features

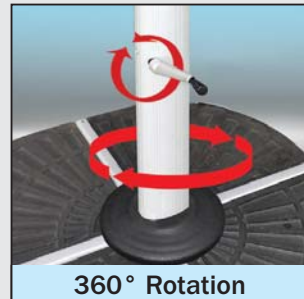
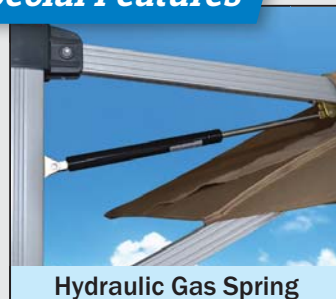

## Optional Features

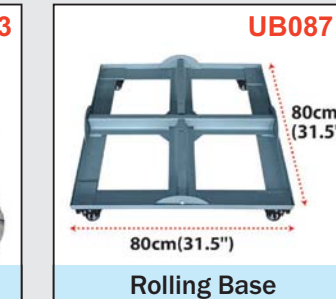

# AUTO ROMA

Automatic Cantilever Umbrella

- U6-250XLA** ☒ Square 8' x 8' (2.5 x 2.5m)
- U6-203LA** ☒ Rectangular 6.5' x 10' (2 x 3m)
- U6-303LA** ☒ Square 10' x 10' (3 x 3m)
- U6-304LA** ☒ Rectangular 10' x 13' (3 x 4m)



# AUTO ROMA

Automatic Cantilever Umbrella

- U6-250XLA** ☒ Square 8' x 8' (2.5 x 2.5m)
- U6-203LA** ☒ Rectangular 6.5' x 10' (2 x 3m)
- U6-303LA** ☒ Square 10' x 10' (3 x 3m)
- U6-304LA** ☒ Rectangular 10' x 13' (3 x 4m)

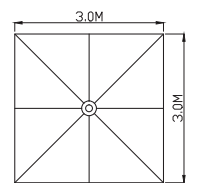

**U6-303LA**  
 □ 3X3M  
 = 9M<sup>2</sup>  
 ≈ 45KG  
 ≈ 48KG  
 60KM/H



Remote Control



Crank Open & Close One Step

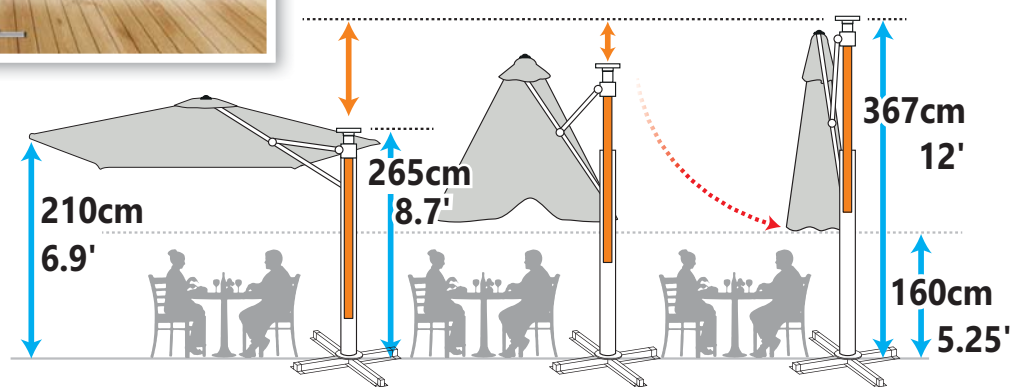

**Free Seating**

No need to remove seating or tables beforehand



**Protective Cover**



PC-03 for U6-303LA

## Special Features



Rechargeable Battery

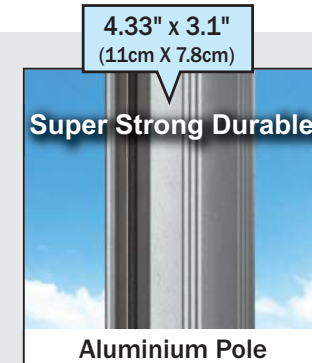

Super Strong Durable

Aluminium Pole

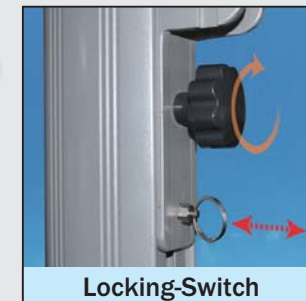

Locking-Switch



Aluminium Frame

# X-ROMA

Cantilever Umbrella

- U6-250X** ☒ Square 8' x 8' (2.5 x 2.5m)
- U6-203** ☒ Rectangular 6.5' x 10' (2 x 3m)
- U6-303** ☒ Square 10' x 10' (3 x 3m)
- U6-304** ☒ Rectangular 10' x 13' (3 x 4m)



# X-ROMA

Cantilever Umbrella

- U6-250X** ☒ Square 8' x 8' (2.5 x 2.5m)
- U6-203** ☒ Rectangular 6.5' x 10' (2 x 3m)
- U6-303** ☒ Square 10' x 10' (3 x 3m)
- U6-304** ☒ Rectangular 10' x 13' (3 x 4m)

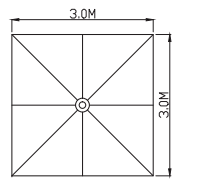

**U6-303**  
 □ 3X3M  
 = 9.0M<sup>2</sup>  
 ≈ 44KG  
 ≈ 47KG  
 60KM/H



## Metal Mechanism System

Crank Open & Close One Step



**Optional Features**

**UB046**  
SAND 275LBS (125kgs)

Sand Water Weight Base

**UB063**  
93cm(3')

Rolling Base Round

160cm (5.25')

Extra Closing Height

1 BOLTS

Mount the base with bolts

2 BOLTS

Granite Weight

## Crank Open & Close One Step



## Special Features

360° Rotation

4.33" x 3.1" (11cm X 7.8cm)

Super Strong Durable

Aluminium Pole

Locking-Switch

Aluminium Frame

# AUTO ROMA

Automatic Cantilever Umbrella

**U6-300LA**  Round 10' (3m)  
**U6-350LA**  Round 11.5' (3.5m)

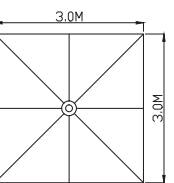

**U6-303LA**  
 □ 3X3M  
 ≈ 9M<sup>2</sup>  
 ≈ 45KG  
 ≈ 48KM/H

**Free Seating**  
 No need to remove seating  
 or tables beforehand

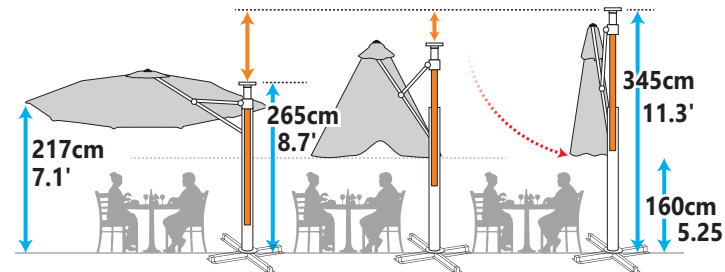

## Special Features

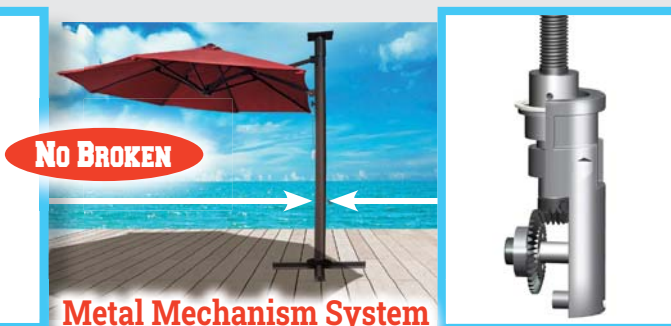
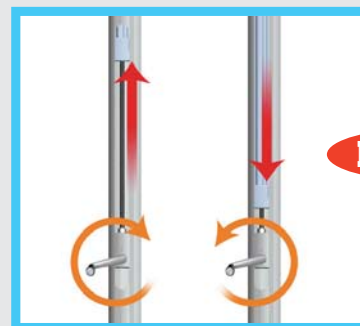

# X-ROMA

Cantilever Umbrella

**U6-300**  Round 10' (3m)  
**U6-350**  Round 11.5' (3.5m)

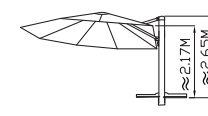
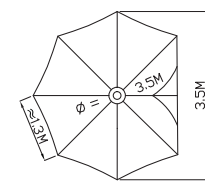

**U6-350**  
 Ø 3.5M  
 ≈ 9.6M<sup>2</sup>  
 ≈ 45KG  
 ≈ 48KM/H

## Metal Mechanism System

Crank Open & Close One Step



## System

**160cm (5.25')**  
Extra Closing Height

**4.33" x 3.1"**  
(11cm X 7.8cm)

**Super Strong Durable**

**GRAY**

Aluminium Pole

**Mount the base with bolts**

**Concrete Foot Tube**

50cm, 30cm, 20cm, 10cm

**Locking-Switch**

# AUTO OPEN

Solar Powered Umbrella

**U5-303LA** ☒ Square 10' X 10' (3 x 3m)  
**U5-350XLA** ☒ Square 11.5' X 11.5' (3.5 x 3.5m)



**US**  
GENERATION-V

# AUTO OPEN

Solar Powered Umbrella

**U5-350LA** ☒ Octagonal 11.5' (3.5m)  
**U5-400LA** ☒ Octagonal 13' (4m)



**US**  
GENERATION-V

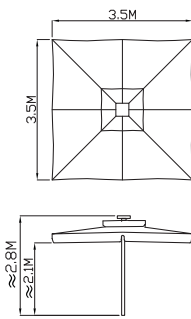

Remote Control



One Step  
Crank  
Open & Close



**U5-350XLA**  
 □ 3.5X3.5M  
 = 12.25M<sup>2</sup>  
 ≈ 36KG  
 ≈ 40KG  
 95KM/H



Dimensions & Technical Data

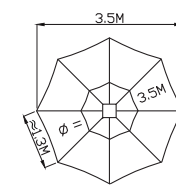
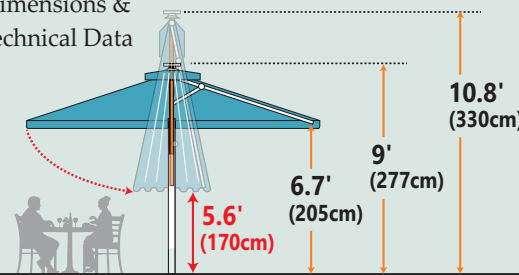

Remote Control



One Step  
Crank  
Open & Close

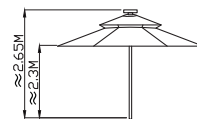

**U5-350LA**  
 Ø 3.5M  
 ≈ 9.6M<sup>2</sup>  
 ≈ 35KG  
 ≈ 39KG  
 95KM/H



## Optional Features



Sun Sensor



Wind Sensor



Granite Weight



Rolling Base

# Models by Shape & Size Specifications

## U8 GENERATION-VIII

<b>U8-303F-2</b> □ 3 x 3 M = 9.0 M <sup>2</sup> ≈ 23 KG ≈ 27 KG 95 KM/H	<b>U8-350XF-2</b> □ 3.5 x 3.5 M = 12.25 M <sup>2</sup> ≈ 24 KG ≈ 28 KG 94 KM/H	<b>U8-404F-2</b> □ 4 x 4 M = 16.0 M <sup>2</sup> ≈ 25 KG ≈ 29 KG 93 KM/H	<b>U8-250X</b> □ 2.5 x 2.5 M = 6.25 M <sup>2</sup> ≈ 19 KG ≈ 22 KG 92 KM/H



**U8-303**

<b>U7-304</b> □ 3 x 4 M = 12.0 M <sup>2</sup> ≈ 25.5 KG ≈ 28.5 KG 59 KM/H	<b>U7-300L</b> ∅ 3 M = 7.06 M <sup>2</sup> ≈ 33 KG ≈ 36 KG 60 KM/H	<b>U7-350L</b> ∅ 3.5 M = 9.6 M <sup>2</sup> ≈ 34 KG ≈ 37 KG 55 KM/H	<b>U7-300</b> ∅ 3 M = 7.06 M <sup>2</sup> ≈ 33 KG ≈ 36 KG 60 KM/H	<b>U7-350</b> ∅ 3.5 M = 9.6 M <sup>2</sup> ≈ 34 KG ≈ 37 KG 55 KM/H



**U6-303LA**

<b>U8-270X</b> □ 2.7 x 2.7 M = 7.29 M <sup>2</sup> ≈ 20 KG ≈ 23 KG 91 KM/H	<b>U8-303</b> □ 3 x 3 M = 9.0 M <sup>2</sup> ≈ 21 KG ≈ 24 KG 90 KM/H	<b>U8-350X</b> □ 3.5 x 3.5 M = 12.25 M <sup>2</sup> ≈ 22 KG ≈ 25 KG 89 KM/H	<b>U8-404</b> □ 4 x 4 M = 16.0 M <sup>2</sup> ≈ 23 KG ≈ 26 KG 88 KM/H	<b>U8-350-2</b> ∅ 3.5 M = 9.6 M <sup>2</sup> ≈ 25 KG ≈ 29 KG 95 KM/H	<b>U8-400-2</b> ∅ 4 M = 12.56 M <sup>2</sup> ≈ 26 KG ≈ 30 KG 94 KM/H	<b>U8-300</b> ∅ 3 M = 7.06 M <sup>2</sup> ≈ 23 KG ≈ 27 KG 91 KM/H

## U6 GENERATION-VI

<b>U6-250XLA</b> □ 2.5 x 2.5 M = 6.25 M <sup>2</sup> ≈ 44 KG ≈ 47 KG 65 KM/H	<b>U6-303LA</b> □ 3 x 4 M = 9.0 M <sup>2</sup> ≈ 45 KG ≈ 48 KG 60 KM/H	<b>U6-203LA</b> □ 2 x 3 M = 6.0 M <sup>2</sup> ≈ 43 KG ≈ 47 KG 60 KM/H	<b>U6-304LA</b> □ 3 x 4 M = 12.0 M <sup>2</sup> ≈ 46 KG ≈ 49 KG 55 KM/H	<b>U6-250X</b> □ 2.5 x 2.5 M = 6.25 M <sup>2</sup> ≈ 43 KG ≈ 46 KG 65 KM/H	<b>U6-303</b> □ 3 x 3 M = 9.0 M <sup>2</sup> ≈ 44 KG ≈ 47 KG 60 KM/H

<b>U8-350</b> ∅ 3.5 M = 9.6 M <sup>2</sup> ≈ 24 KG ≈ 28 KG 90 KM/H	<b>U8-400</b> ∅ 4 M = 12.56 M <sup>2</sup> ≈ 25 KG ≈ 29 KG 89 KM/H	<b>U7-250XL</b> □ 2.5 x 2.5 M = 6.25 M <sup>2</sup> ≈ 22.5 KG ≈ 25 KG 65 KM/H	<b>U7-270XL</b> □ 2.7 x 2.7 M = 7.29 M <sup>2</sup> ≈ 23.5 KG ≈ 26.5 KG 63 KM/H	<b>U7-303L</b> □ 3 x 3 M = 9.0 M <sup>2</sup> ≈ 24.5 KG ≈ 27.5 KG 60 KM/H	<b>U7-203L</b> □ 2 x 3 M = 6.0 M <sup>2</sup> ≈ 21.5 KG ≈ 24.5 KG 60 KM/H

## U7 GENERATION-VII

<b>U7-304L</b> □ 3 x 4 M = 12.0 M <sup>2</sup> ≈ 25.5 KG ≈ 28.5 KG 59 KM/H	<b>U7-250X</b> □ 2.5 x 2.5 M = 6.25 M <sup>2</sup> ≈ 22.5 KG ≈ 25 KG 65 KM/H	<b>U7-270X</b> □ 2.7 x 2.7 M = 7.29 M <sup>2</sup> ≈ 26 KG ≈ 26 KG 60 KM/H	<b>U7-303</b> □ 3 x 3 M = 9.0 M <sup>2</sup> ≈ 24.5 KG ≈ 27 KG 60 KM/H	<b>U7-203</b> □ 2 x 3 M = 6.0 M <sup>2</sup> ≈ 21.5 KG ≈ 24.5 KG 60 KM/H



**U7-303L**

## U5 GENERATION-V

<b>U5-303LA</b> □ 3 x 3 M = 9.0 M <sup>2</sup> ≈ 35 KG ≈ 39 KG 96 KM/H	<b>U5-350XLA</b> □ 3.5 x 3.5 M = 12.25 M <sup>2</sup> ≈ 36 KG ≈ 40 KG 95 KM/H	<b>U5-350LA</b> ∅ 3.5 M = 9.6 M <sup>2</sup> ≈ 35 KG ≈ 39 KG 95 KM/H	<b>U5-400LA</b> ∅ 4 M = 12.56 M <sup>2</sup> ≈ 36 KG ≈ 40 KG 94 KM/H



**U5-303LA**



# PARTY UMBRELLA

**U247-250X** ☒ Square 8' x 8' (2.5 x 2.5m)

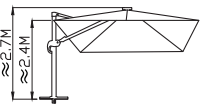
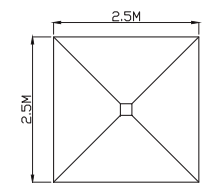

**U247-250X**  
 ☐ 2.5 X 2.5M  
 = 6.25M<sup>2</sup>  
 ≈ 20.5KG  
 ≈ 23.5KG  
 65KM/H



**ALUMINIUM FRAME**  
 DURABLE & STRENGTH



## Optional Features

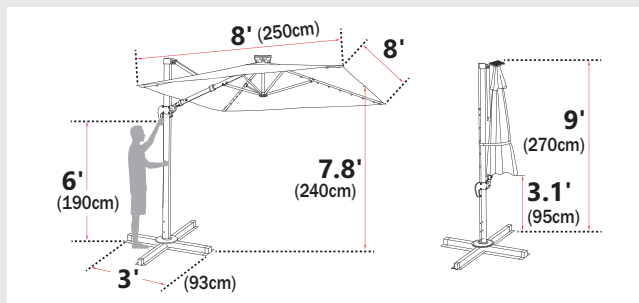
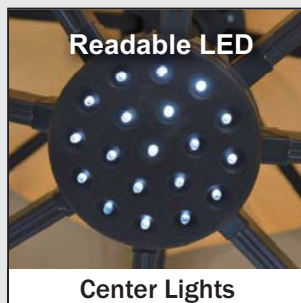

# PARTY UMBRELLA

**U247-350** ☒ Octagonal 11.5' (3.5m)  
**U247-3X** ☒ Square 10' x 10' (3 x 3m)

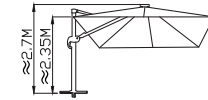
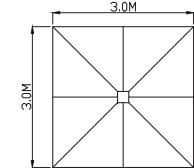

**U247-3X**  
 ☐ 3X3M  
 = 9.0M<sup>2</sup>  
 ≈ 23KG  
 ≈ 26KG  
 60KM/H



**ALUMINIUM FRAME**  
 DURABLE & STRENGTH

### Optional Features

**360° ROTATION**  
 SHADE 1    SHADE 2

**UB063**  
 Rolling Base Round

**UB046**  
 SAND 275LBS (125kgs)  
 Sand Water Weight Base

### Special Features

**Up And Down Tilt**



**180° Side Tilt**

**360° Rotation**

**Power Switch**

# BIG ROMA SQUARE

Cantilever Umbrella

- U210-303**  Square 10' x 10' (3 x 3m)
- U210-350X**  Square 11.5' x 11.5' (3.5 x 3.5m)
- U210-304**  Rectangular 13' x 10' (4 x 3m)



# BIG ROMA SQUARE

Cantilever Umbrella

- U212-303**  Square 10' x 10' (3 x 3m)
- U212-304**  Rectangular 13' x 10' (4 x 3m)

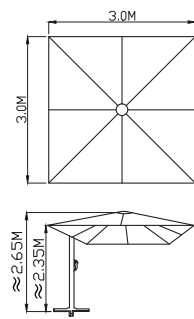

**U210-303**  
 □ 3X3M  
 = 9.0M<sup>2</sup>  
 ≈ 24.5KG  
 ≈ 27KG  
 60KM/H



**ALUMINIUM FRAME**  
 DURABLE & STRENGTH



**U210-304**

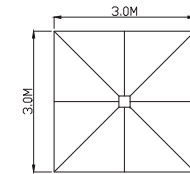

**U212-303**  
 □ 3X3M  
 = 9.0M<sup>2</sup>  
 ≈ 24.5KG  
 ≈ 27KG  
 60KM/H



**ALUMINIUM FRAME**  
 DURABLE & STRENGTH

## Optional Features

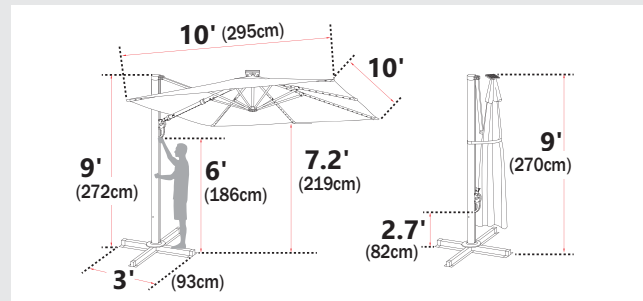
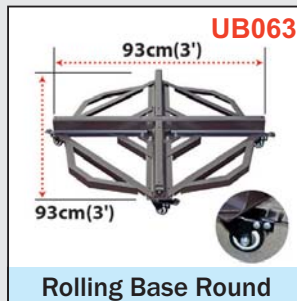

## Special Features

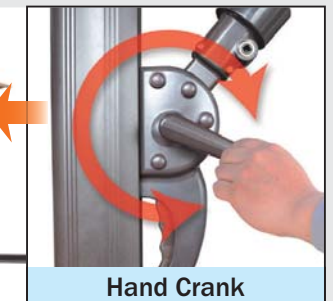
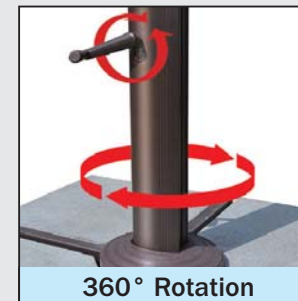
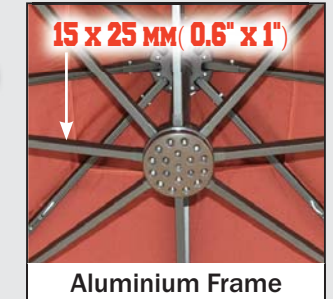

# BIG ROMA OCTAGONAL

Cantilever Umbrella

**U210-350**  Octagonal 11.5' (3.5m)  
**U210-400**  Octagonal 13' (4m)

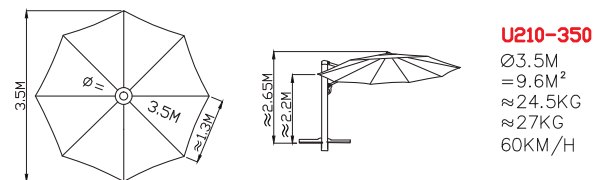

### 4 Different Ways To Mount Base

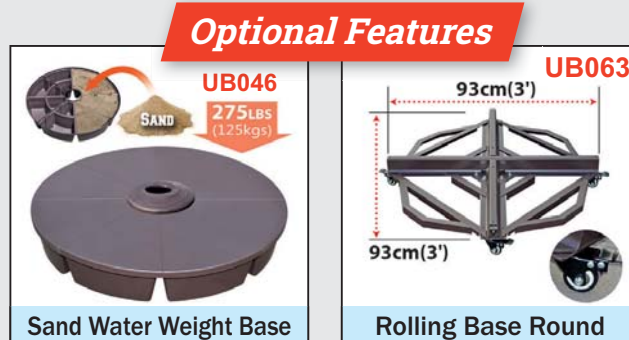
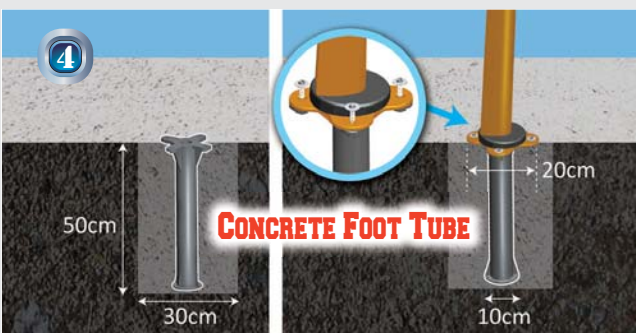
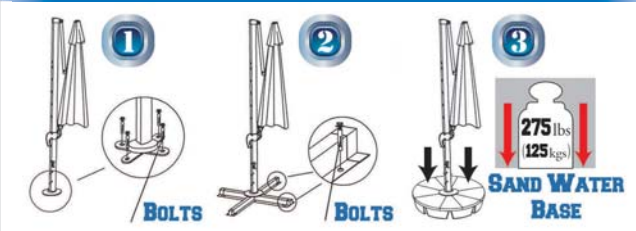

# BIG ROMA OCTAGONAL

Cantilever Umbrella

**U212-350**  Octagonal 11.5' (3.5m)  
**U212-400**  Octagonal 13' (4m)

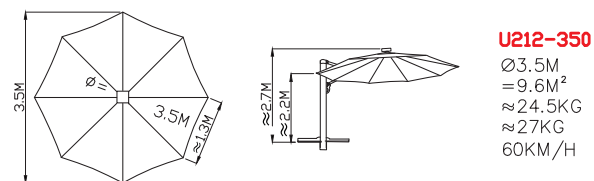

### Special Features

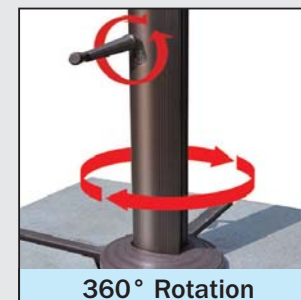

# DELUXE ROMA SQUARE

Cantilever Umbrella

**U125-303** ☒ Square 10' x 10' (3 x 3m)

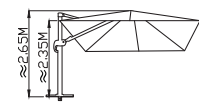
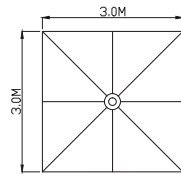

**U125-303**  
 □ 3X3M  
 = 9.0M<sup>2</sup>  
 ≈ 24.5KG  
 ≈ 27KG  
 60KM/H



**ALUMINIUM FRAME**  
 DURABLE & STRENGTH

## Special Features

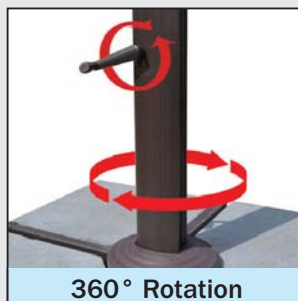
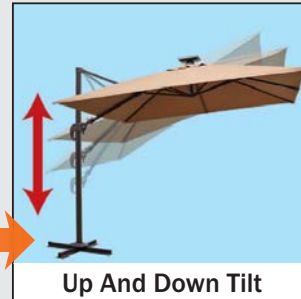
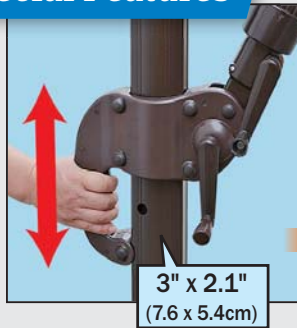

# DELUXE ROMA SQUARE

Cantilever Umbrella

**U124-303** ☒ Square 10' x 10' (3 x 3m)

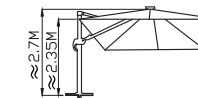
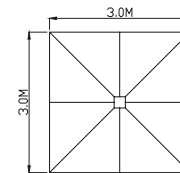

**U124-303**  
 □ 3X3M  
 = 9.0M<sup>2</sup>  
 ≈ 24.5KG  
 ≈ 27KG  
 60KM/H



**ALUMINIUM FRAME**  
 DURABLE & STRENGTH



## 4 Different Ways To Mount Base

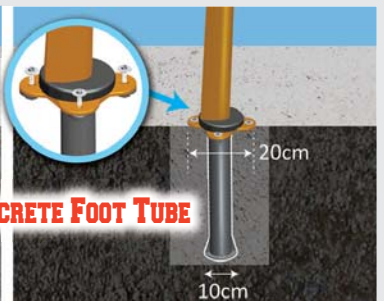
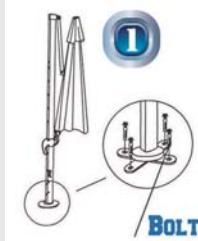

# DELUXE ROMA OCTAGONAL

Cantilever Umbrella

**U125-350**  Octagonal 11.5' (3.5m)



# DELUXE ROMA OCTAGONAL

Cantilever Umbrella

**U124-350**  Octagonal 11.5' (3.5m)

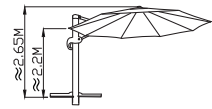
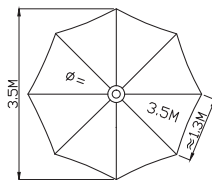

**U125-350**  
 Ø3.5M  
 ≈9.6M<sup>2</sup>  
 ≈25.5KG  
 ≈27.5KG  
 60KM/H



**ALUMINIUM FRAME**  
 DURABLE & STRENGTH

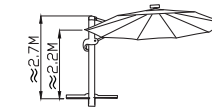
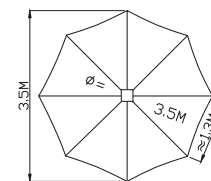

**U124-350**  
 Ø3.5M  
 ≈9.6M<sup>2</sup>  
 ≈25.5KG  
 ≈27.5KG  
 60KM/H



**UC004-W**  
**PE**  
 Protective Cover

## Special Features

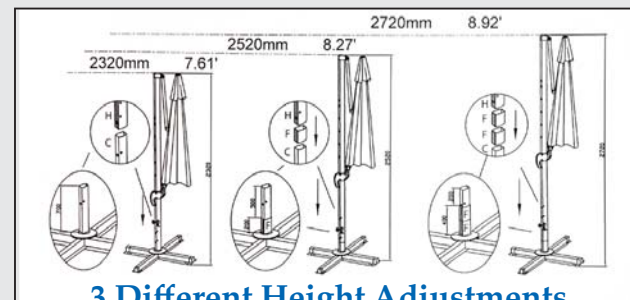
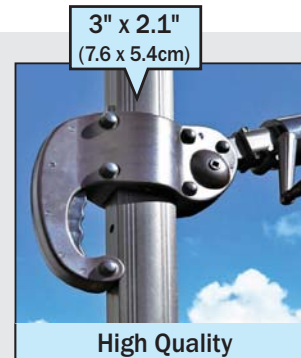
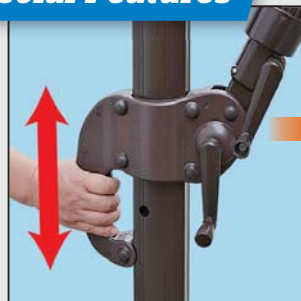

## Optional Features



# ANTI WIND 11

Cantilever Umbrella

**U142-11** Round 11' (3.4m)

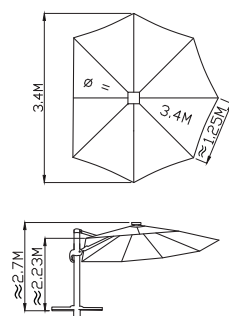

**U142-11**  
 Ø3.4M  
 =9.07M<sup>2</sup>  
 ≈25KG  
 ≈28KG  
 65KM/H



**ALUMINIUM FRAME**  
 DURABLE & STRENGTH



**180° TILT FUNCTION**  
**360° ROTATION FEATURE**



**Wind Resistant**  
**Up To 100 KPH!**

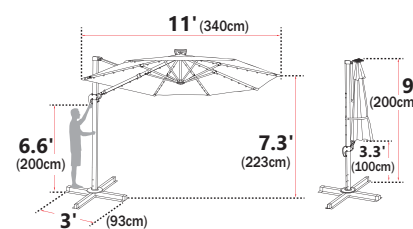

## Optional Features

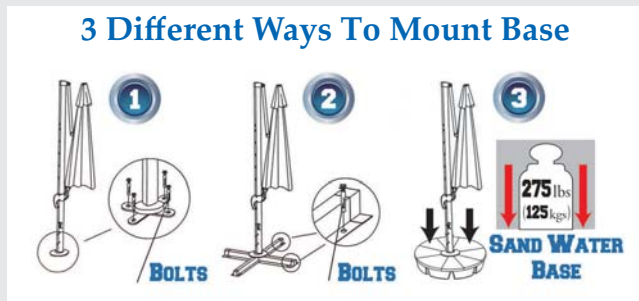
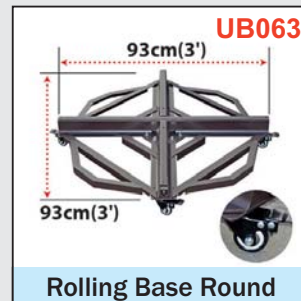

# ANTI WIND 8

Cantilever Umbrella

**U136-8X** Square 8' x 8' (2.5 x 2.5m)

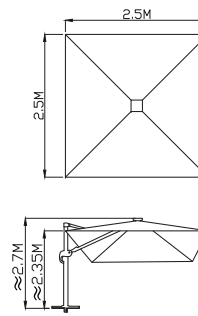

**U136-8X**  
 □2.5X2.5M  
 =6.25M<sup>2</sup>  
 ≈24KG  
 ≈27KG  
 65KM/H



**ALUMINIUM FRAME**  
 DURABLE & STRENGTH



**180° TILT FUNCTION**  
**360° ROTATION FEATURE**



**Wind Resistant**  
**Up To 100 KPH!**

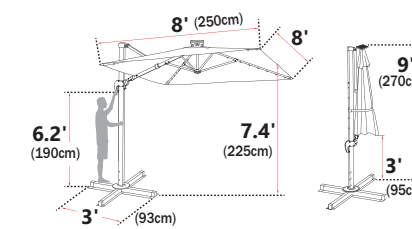

## Special Features

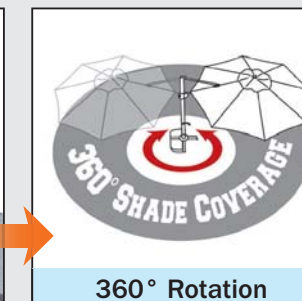
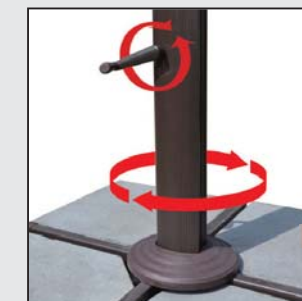
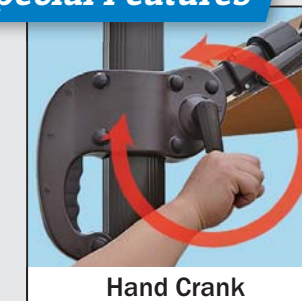

# HOTELBRELLA

Heavy-duty

- U024-2-300** ☉ Octagonal 10' (3m)
- U024-2-350** ☉ Octagonal 11.5' (3.5m)
- U161-202** ☐ Square 6.5' x 6.5' (2 x 2m)
- U161-303** ☐ Square 10' x 10' (3 x 3m)
- U161-304** ☐ Rectangular 10' x 13' (3 x 4m)

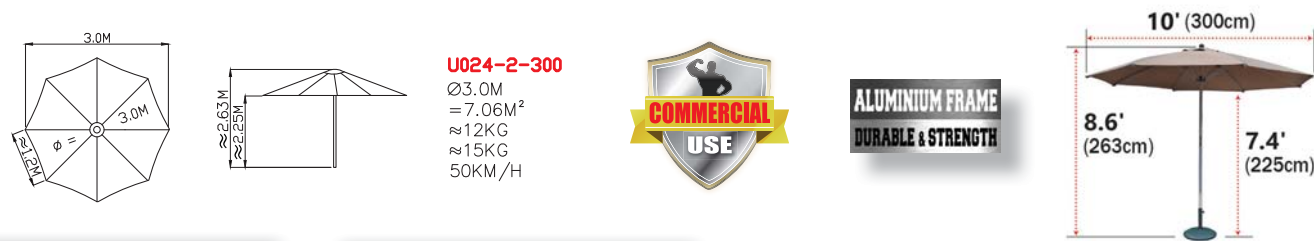

### Special Features

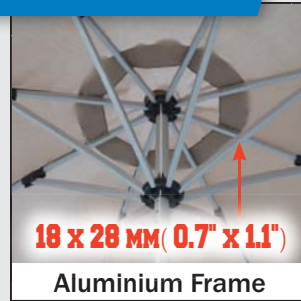

### Optional Features



# HOTELBRELLA

Heavy-duty

- U050-230** ☉ Octagonal 7.6' (2.3m)
- U050-250** ☉ Octagonal 8' (2.5m)
- U050-270** ☉ Octagonal 9' (2.7m)
- U050-300** ☉ Octagonal 10' (3m)

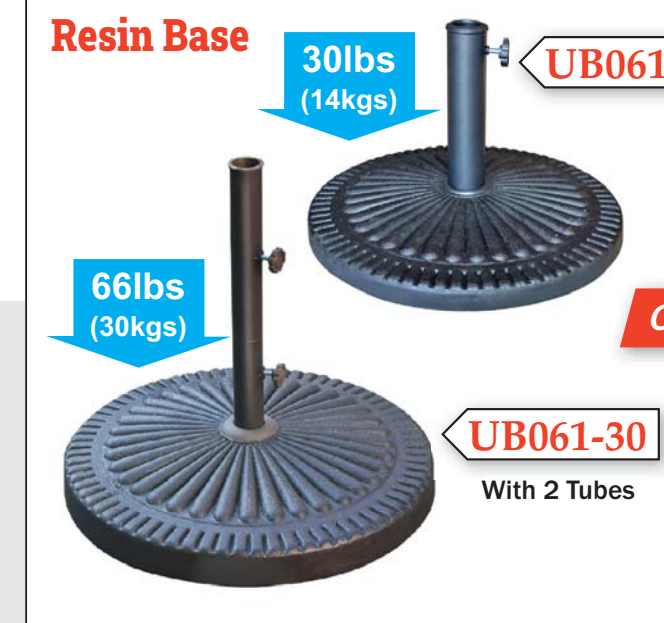
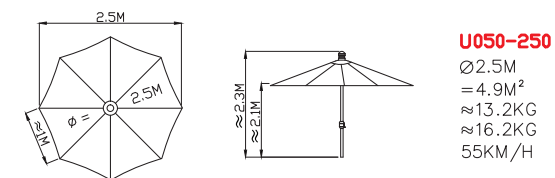

### Optional Features



### Special Features

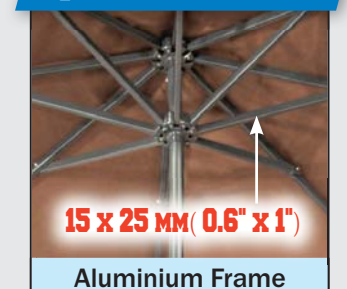



# NEW BANANA

Hanging Umbrella

- U007-270**  Octagonal 9' (2.7m)
- U007-300**  Octagonal 10' (3m)
- U007-250X**  Square 8' x 8' (2.5x 2.5m)
- U007-203**  Rectangular 10' x 6.5' (3 x 2m)
- U007-7-270**  Octagonal 9' (2.7m)
- U007-7-300**  Octagonal 10' (3m)



# HALF UMBRELLA

- U241-270**  Half Octagonal 9' (2.7m)
- U071-2512**  Half Rectangular 8.2' x 4' (2.5 x 1.2m)

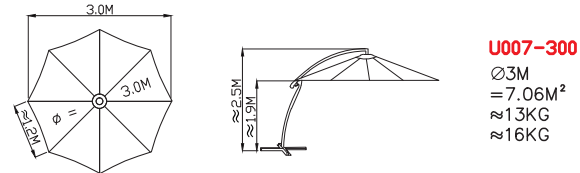

**U007-300**  
 Ø3M  
 = 7.06M<sup>2</sup>  
 ≈ 13KG  
 ≈ 16KG





# FIBREGLASS

Garden Umbrella

- U040-230** Octagonal 7.6' (2.3m)
- U040-270** Octagonal 9' (2.7m)
- U040-250** Octagonal 8' (2.5m)
- U040-300** Octagonal 10' (3m)

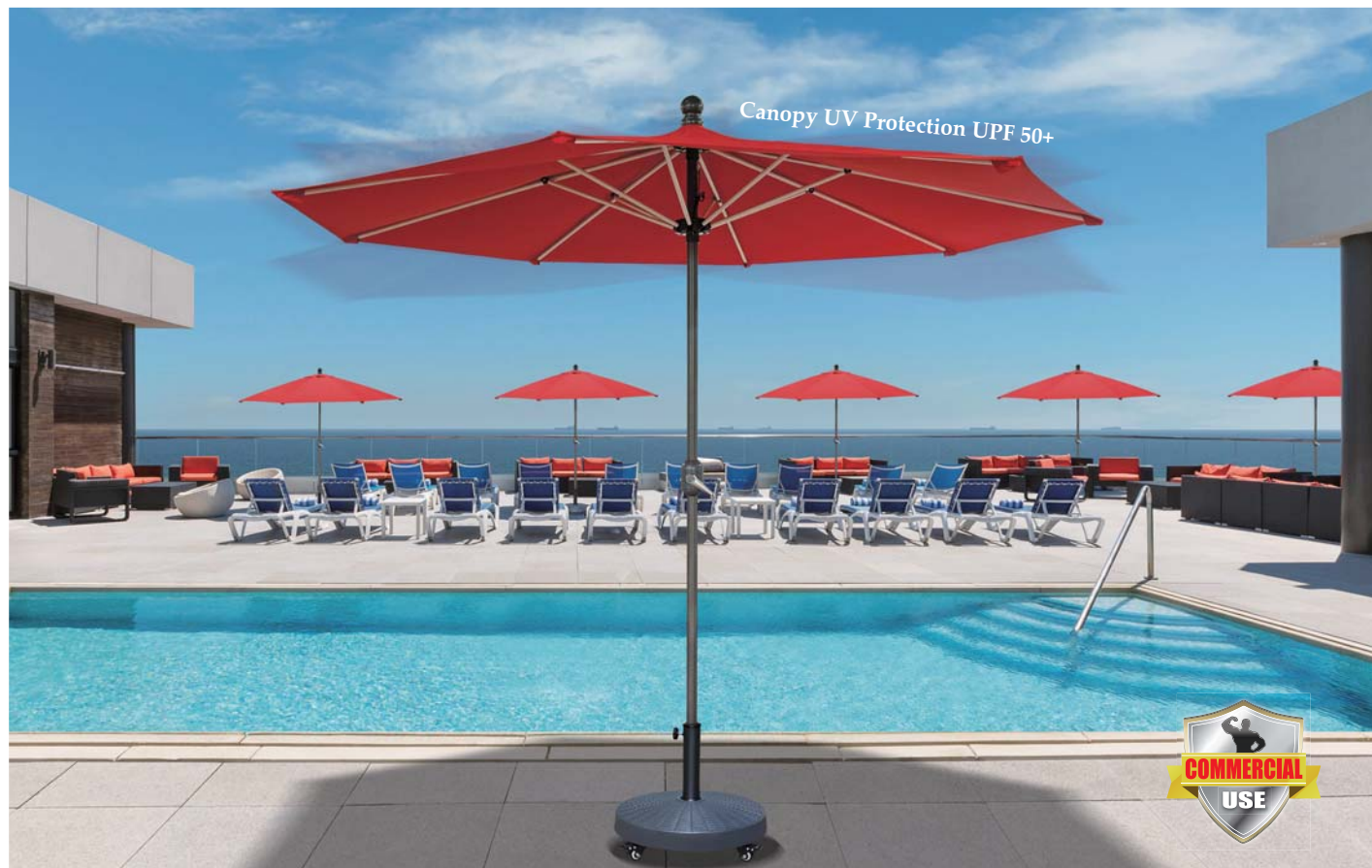

# FIBREGLASS

Garden Umbrella

- U042-250** Round 8' (2.5m)
- U042-270** Round 9' (2.7m)
- U042-300** Round 10' (3m)

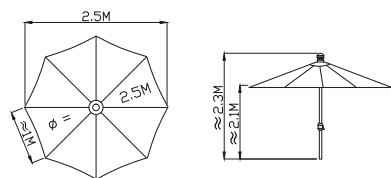

**U040-250**  
 Ø2.5M  
 = 4.9M<sup>2</sup>  
 ≈ 13.5KG  
 ≈ 16.5KG  
 55KM/H



**No Broken**  
 Fibreglass Ribs

### Optional Features



### Special Features

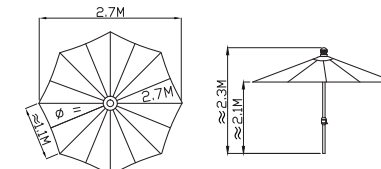

**U042-270**  
 Ø2.7M  
 = 5.7M<sup>2</sup>  
 ≈ 14KG  
 ≈ 17KG  
 55KM/H



**No Broken**  
 Fibreglass Ribs



### Optional Features

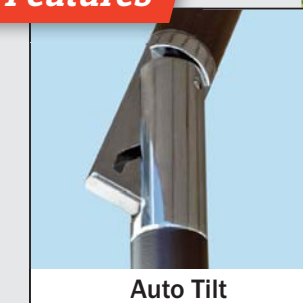
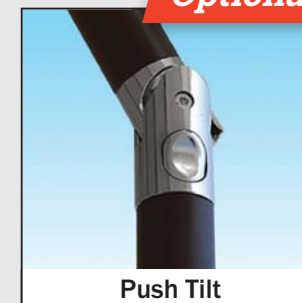



**SOLARBRELLA U021-270** ☼ Octagonal 9' (2.7m)



**SOLARBRELLA U074-203** ☼ Rectangular 10' x 6.5' (3 x 2m)

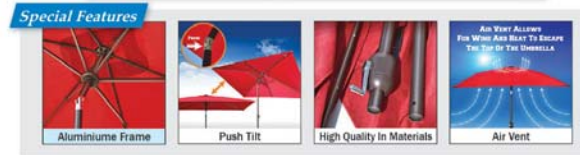

**CRANK & Tilt Umbrella**



**CALIFORNIA Umbrella**



**MELBOURNE Umbrella**



- ☐ U053-270X 2.7x2.7m(9'x9')
- ☐ U053-250X 2.5x2.5m(8'x8')
- ☐ Steel Frame
- ☐ Aluminium Frame
- ☐ Water Proof Polyester Roof
- ☐ UV Protection
- ☐ Sturdy Powder Coating

Colour: ■ Burgundy Black ■ Tan ■ Taupe



**BALCONY Umbrella**



- ☐ U049-203 2x3m(6.5' x 10')
- ☐ U049-202 2x2m(6.5'x6.5')

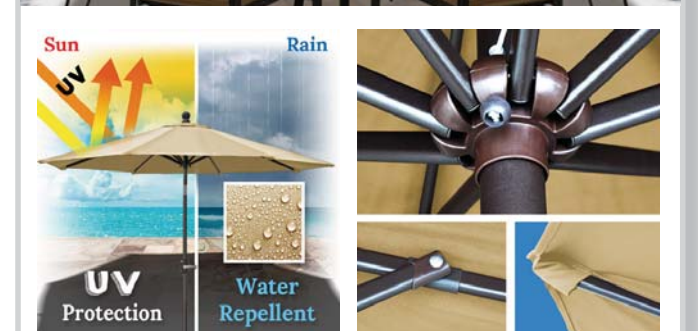

# BASE



# Fabrics

sunbrella Color UPF 50+ 100% sunbrella acryl 270g/m2



Polyester Color UPF 50+ 100% polyester



# Special Features



# Frame Structures

**1. Aluminium** Powder coating, anodized  
 Heavy Duty: 5 years warranty  
 Economic: 2 years warranty

**2. Steel** Powder coating  
 Heavy Duty: 5 years warranty  
 Economic: 2 years warranty

**3. Stainless looking steel** Aluminium polishing anodized  
 Heavy Duty: 5 years warranty  
 Economic: 2 years warranty

**4. Wood** China hard wood  
 Heavy Duty: 5 years warranty  
 Economic: 2 years warranty

**PULLEY OPEN SYSTEM**      **CRANK & TILT SYSTEM**

# Package

**1**

**2**

**3**

**4**

# Factory Tour



- 45 minutes from Ningbo downtown (or Ningbo airport)
- 2.5 hours from Shanghai airport
- 45 minutes from Ningbo sea port



Replacement canopy

## Umbrellas

Canopy replacement will be a good saving way to have a new fashion garden umbrellas or gazebos after the first season, as the inside frame structure of your umbrellas or gazebos will last longer than canopy which is exposed in the air always and will be destroyed by sun & rain easily.

	Φ2.1M (Φ7') Φ2.3M (Φ7.5') Φ2.5M (Φ8') Φ2.75M (Φ9') Φ3M (Φ10')	<input checked="" type="checkbox"/>
<b>6 Ribs</b>		
	Φ2.1M (Φ7') Φ2.3M (Φ7.5') Φ2.5M (Φ8') Φ2.75M (Φ9') Φ3M (Φ10')	<input type="checkbox"/>
<b>6 Ribs</b>		
	3x3M (10'x10') 2x3M (6.5'x10')	<input type="checkbox"/>
<b>6 Ribs</b>		
	3x3M (10'x10') 2x3M (6.5'x10')	<input type="checkbox"/>
<b>6 Ribs</b>		
	Φ2.75M (Φ9') Φ3M (Φ10') Φ3.5M (Φ11'6")	<input type="checkbox"/>
<b>8 Ribs</b>		
	Φ2.75M (Φ9') Φ3M (Φ10') Φ3.5M (Φ11.5')	<input type="checkbox"/>
<b>8 Ribs</b>		

Replacement canopy

## GAZEBOS

Canopy replacement will be a good saving way to have a new fashion garden umbrellas or gazebos after the first season, as the inside frame structure of your umbrellas or gazebos will last longer than canopy which is exposed in the air always and will be destroyed by sun & rain easily.

	3x3M (10'x10') 3x4M (10'x13')	<input checked="" type="checkbox"/>
	3x3M (10'x10') 3x4M (10'x13')	<input type="checkbox"/>
	2x3M (6.5'x10') 3x4M (10'x13') 3x6M (10'x19.5')	<input type="checkbox"/>
	3x3M (10'x10') 3x4M (10'x13')	<input type="checkbox"/>

